

Location: _____



FS1980

12" X 12" X 6" REPLACEMENT STAINLESS STEEL FLOOR SINK LINER

Specification: MIFAB Series FS1980, 16 gauge, fabricated stainless steel, Type 304 floor sink replacement liner with internal dome strainer. Complete with external pipe gasket seal and light duty slotted loose set stainless steel grate.

Function: Used in areas where the porcelain enamel floor sink has chipped and / or worn off from already installed 12" x 12" x 6" deep floor sinks. The FS1980 stainless steel liner is inserted into the existing porcelain enamel floor sink.

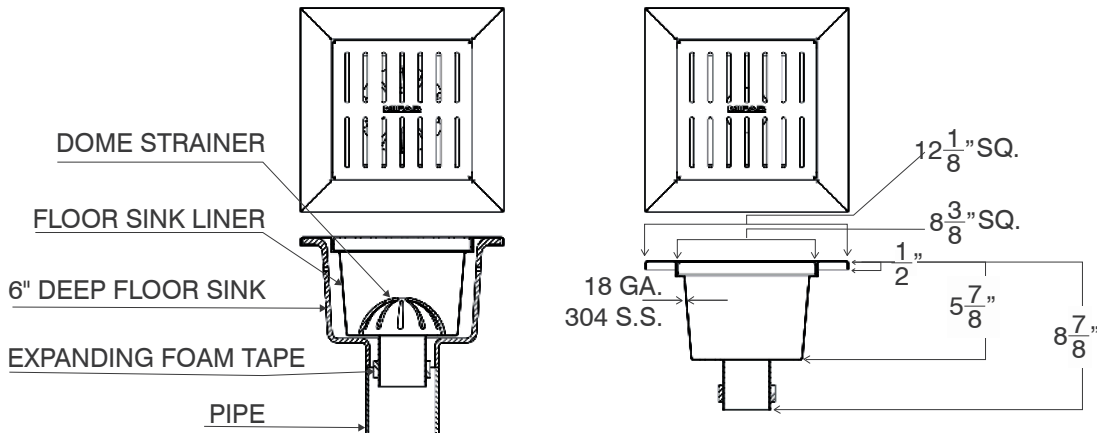
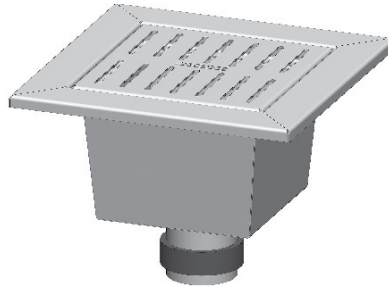

STABILIZING PLATE FOR 8" X 8" FLOOR SINKS

MODEL NO.	PIPE SIZE	WEIGHT (Lbs.)	FREE AREA
FS1982	2"	6	22.00"
FS1983	3"	6	22.00"
FS1984	4"	6	22.00"

SUFFIX	OPTIONAL VARIATIONS
-5	Sediment bucket (FS1750-PB)
-22	Less Stainless Steel grate (deduct)
-150	1/2 grate
-175	3/4 grate

CALIFORNIA PROPOSITION 65 WARNING. This product contains chemicals known to the State of California to cause cancer and birth defects or other reproductive harm.

Job Name: _____ Page No: _____
 Section No: _____ Contractor: _____
 Schedule No: _____ Purchase Order No: _____