

Location: _____







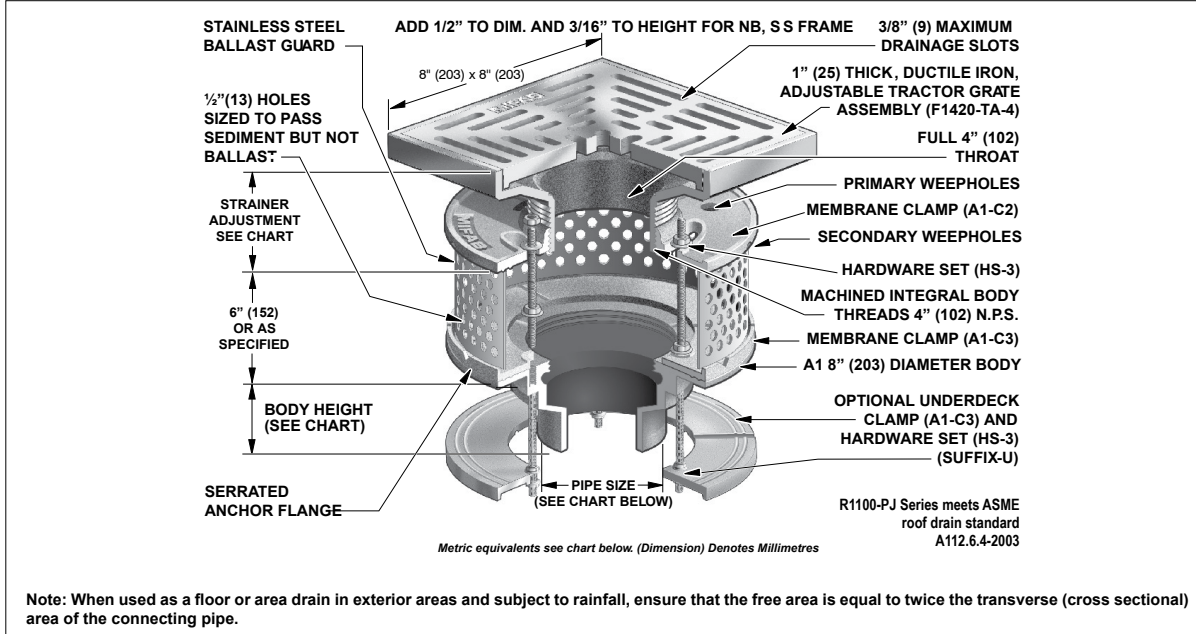

R1100-PJ

PROMENADE DECK DRAIN WITH STAINLESS STEEL PERFORATED EXTENSION

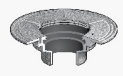
Specification: MIFAB® Series R1100-PJ lacquered cast iron roof drain with anchor flange, cast iron water proofing membrane clamp ring, stainless steel perforated extension and standard 1" (25) thick, 8" (203) square adjustable ductile iron tractor grate.

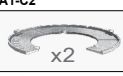
Function: Used in flat roofs and decks designed for promenade or recreational areas. Square top blends in with tile and brick patterns and has enough free area for efficient drainage of rainwater. Narrow, 3/8" (9) drainage slots prevent debris from entering the drain line. Extra wide anchor flange and membrane clamp with tongue in groove design provides for secure grip of membrane and roof flashing materials.



- PARTS:**
-  A1 BODY
 -  A1-C2
 -  A1-C3 x2
 -  A1-BG
 -  F1420-TA-4
 -  HS-3

Note: When used as a floor or area drain in exterior areas and subject to rainfall, ensure that the free area is equal to twice the transverse (cross sectional) area of the connecting pipe.

PIPE SIZE	BODY HEIGHT				
	NO HUB (STANDARD)	PUSH ON (P)	THREADED (T)	INSIDE CAULK (X)	PVC (-30) / ABS (-31)
2" (51)	3" (76)	3 3/8" (86)	2 1/4" (57)	3 3/4" (95)	2 5/8" (67)
3" (76)	3" (76)	3 3/8" (86)	2 5/8" (67)	3 3/4" (95)	3 1/4" (83)
4" (102)	3" (76)	3 3/8" (86)	2 5/8" (67)	3 3/4" (95)	3 1/2" (89)
5" (127)	3" (76)	—	2 5/8" (67)	6 7/8" (175)	—
6" (152)	3 1/2" (89)	6 7/8" (175)	—	—	—

Note: Deck opening - 6 3/8" (160) with sump receiver - 8 1/2" (216)

Suffix	Description
-1	Nickel bronze (vener)
-3	Stainless steel (vener)
-4	Ductile iron grate (standard)
-5	Sediment bucket
-6	Vandal proof dome (metal dome only)
-11	Acid resistant epoxy coating
-12	Galvanized metal dome
-13	Galvanized body, membrane clamp and dome
-15	Adjustable extension
-21	Secondary flat stainless steel strainer (2", 3", 4")
-28	Stainless steel body (Type 304) (2", 3", 4")
-30	PVC socket connection body
-31	ABS socket connection body
-34	Closure plug
-90	Threaded side outlet (2", 3", 4")

-90NH	No Hub side outlet (cast iron only) (2", 3", 4")
-95	Client Logo
-B	Sump receiver
-BA	Buy America Act compliant product
-E	Adjustable extension
P	Push on outlet
-PA	Pennsylvania Steel Act compliant product
(Standard)	No hub outlet
T	Threaded outlet (2", 3", 4")
-U	Underdeck clamp
-U3	Underdeck clamp with cutaway side
-W-1	Water proofing flange
X	Inside caulk outlet (2", 3", 4")
-XJ	Vertical expansion joint (see R1900)
-Z	Extended wide elastomeric flange

CALIFORNIA PROPOSITION 65 WARNING. This product contains chemicals known to the State of California to cause cancer and birth defects or other reproductive harm.

Job Name: _____ Page No: _____
 Section No: _____ Contractor: _____
 Schedule No: _____ Purchase Order No: _____